

Acoustic Plaster Ceilings

VoglToptec® System
Technical Information



VoglToptec®



**Attractive in
Appearance,**
Highly Active in Acoustics









The acoustic plaster system
with guaranteed results

Acoustic Plaster Ceilings

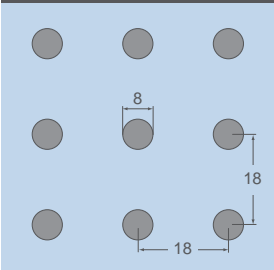
VogIToptec® System

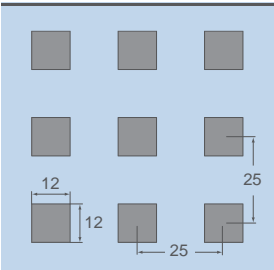
Perforation Patterns and Sound Absorption Values

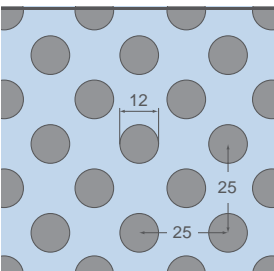

Article	Article No.	Description	Details	m ² / pallet Boards / pallet
	7221100010	Acoustic plaster system panel Reflexio (smooth) Black acoustic fleece on reverse Rated sound absorption: $\alpha_w = 0.10$ Sound absorption class: Not classified Use: To create reflective areas in the ceiling's surface	1206 x 2006 x 12.5 mm Perforated area: 0.0% Weight: 10.0 kg/m ² Long edge: SK Short edge: SK Delivery includes Vogl screw kit	60.5 m ² / pallet 25 boards / pallet 
	7221102110	Acoustic plaster system panel 8/18R Black acoustic fleece on reverse Rated sound absorption: $\alpha_w = 0.70$ sound absorption class C Backed with 30 mm glass wool: $\alpha_w = 0.75$ sound absorption class C	1194 x 2004 x 12.5 mm Perforated area: 15.4% Weight: 8.5 kg/m ² Long edge: SK Short edge: SK Delivery includes Vogl screw kit	59.8 m ² / pallet 25 boards / pallet 
	7221109110	Acoustic plaster system panel 12/25Q Black acoustic fleece on reverse Rated sound absorption: $\alpha_w = 0.75$ sound absorption class C Backed with 30 mm glass wool: $\alpha_w = 0.90$ sound absorption class A	1206 x 2006 x 12.5 mm Perforated area: 22.9% Weight: 7.7 kg/m ² Long edge: SK Short edge: SK Delivery includes Vogl screw kit	60.5 m ² / pallet 25 boards / pallet 
	7231113110	Ultracoustic panel 12/25R DLV Black acoustic fleece on reverse Rated sound absorption: $\alpha_w = 0.80$ sound absorption class B Backed with 30 mm glass wool: $\alpha_w = 0.95$ sound absorption class A	1232.5 x 1950 x 12.5 mm Perforated area: 35.3% Weight: 6.5 kg/m ² Long edge: SK Short edge: SK Delivery includes Vogl screw kit	60.0 m ² / pallet 25 boards / pallet 

VogIToptec® Ultrakustik Panel



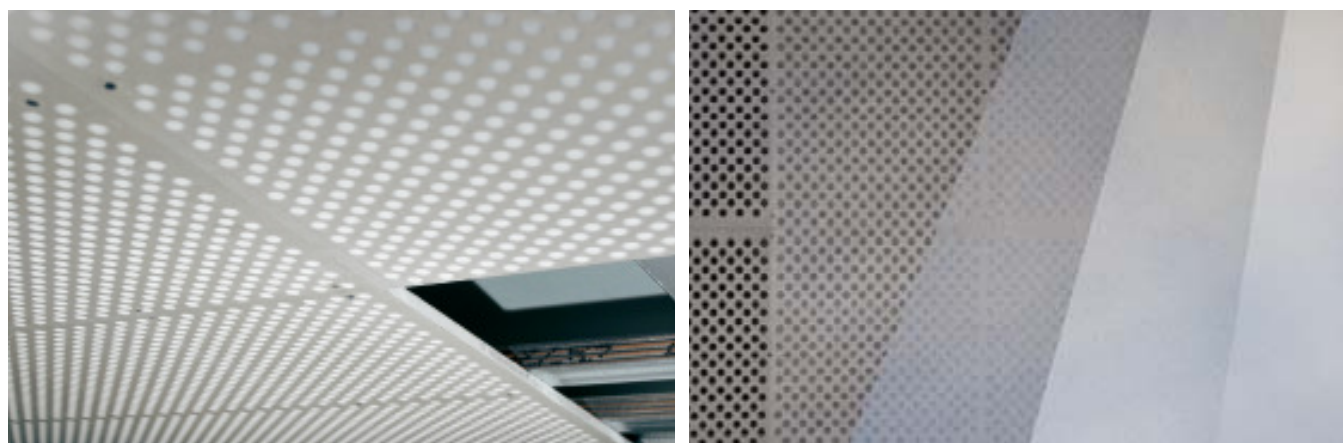



All panels are supplied detailed installation instructions for board perimeter and intermediate screw fixings and stop bars. Perfect smoothness and excellent stability even with very highly perforated areas of up to 35.3%.



Acoustic Plaster Ceilings

VogIToptec® System
System Components



Article	Article No.	Description	Contents	Packing unit Packing units / pallet
	90501300	Vogl Supergrund LF 201 Universal base coat, absorbency regulating, free from solvents and softening agents, low-emission, free from active fogging substances	1 canister = 20 litres	1 PU = 1 canister 24 canisters/pallet
	90605000	VogIToptec® plaster base fleece Special glass fibre fleece as plaster base for coating with acoustic plaster, not flammable, A2, crack-bridging properties, moisture-resistant, dimensionally stable, white colour	Roll width: = 1.145 mm Roll length: = 100 m	1 PU = 1 roll 15 rolls / pallet
	90604000	VogIToptec® Special Adhesive Ready-to-use, non-toxic dispersion adhesive to bond the plaster base fleece to perforated ceiling panels, free from solvents and softening agents, low-emission, free from active fogging substances, ready-mixed product	1 bucket = 16 kg	1 PU = 1 bucket 24 buckets / pallet
	90602000	VogIToptec® Akustik Nano SF Decorative, organically bound, open-pored acoustic machine-applied plaster, very fine texture, particle size up to 0.5 mm, dull matt, high degree of whiteness, ready-mixed product	1 bucket = 18 kg	1 PU = 1 bucket 24 buckets / pallet
	90602100	VogIToptec® Akustik Color Nano SF Decorative, organically bound, open-pored acoustic machine-applied plaster, very fine texture, particle size up to 0.5 mm, ready-mixed product, please state color selection (RAL etc.) when ordering	1 bucket = 18 kg	1 PU = 1 bucket 24 buckets / pallet
	90603000	VogIToptec® Akustik Mineral SF Decorative, minerally bound, open-pored acoustic machine-applied plaster, very fine texture, must be mixed with water on-site	1 bag = 10 kg	1 PU = 1 bag 40 bags / pallet

In-built quality assured!

Our perfectly matched components are fully inspected to guarantee an unparalleled reliability on site and the performance of our acoustic plaster ceilings.

- 1 Acoustic fleece
Factory-supplied
- 2 VoglToptec®
Acoustic plaster
system panel
- 3 Plaster base fleece
Installed on-site
- 4 Acoustic plaster
Installed on-site

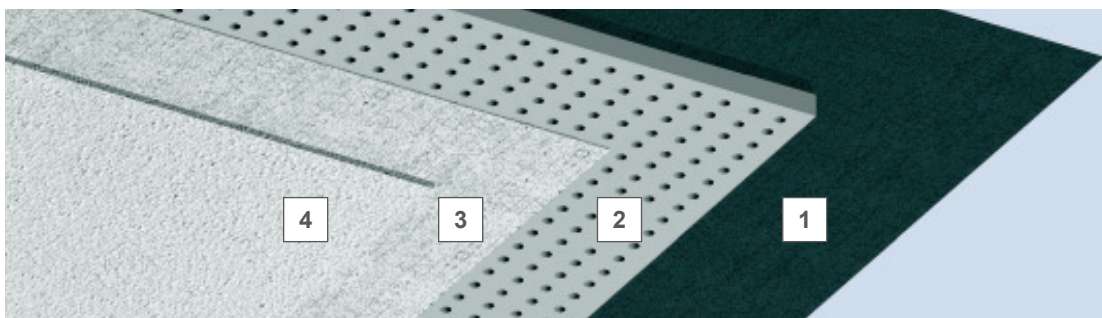

Acoustic Plaster Ceilings

CD/CD Framework
System Structure



The primary profiles are hung from the structural soffit with suspended brackets using fixing materials approved by the relevant building authorities. The grid centres and number of suspended brackets, as well as the fixing device, are subject to site requirements and EN 13964/DIN 18181. The CG 60/27 secondary profiles are attached to the primary profiles CD 60/27 using cross connectors.

CD 60/27 is extended using straight connectors. For primary grid profiles always ensure that the joint is close to a suspended bracket (max. 100 mm). For secondary grid profiles joints are generally offset from each other.

The plasterboards should be installed in accordance with EN 13964/DIN 18181 and the manufacturer's guidelines.

Additional items such as lighting, ventilation, sprinkler systems etc. must be independently supported.

Any changes in the grid resulting from additional ceiling mounted items must be considered.

Construction Specification		Acoustic Plaster Ceiling						
Panel thickness	mm	12.5						
Distributed load	kN/m ²	≤ 0.15					≤ 0.30	
Centre distance of suspended bracket A	mm	1150	1050	1000	950	900	900	750
Centre distance of primary grid X	mm	600	800	900	1000	1100	600	1000
Centre distance of secondary grid Y								
VoglToptec® Acoustic plaster system panel 8/18R, 12/25Q, Reflexio (smooth)	mm	334						
VoglToptec® Ultracoustic panel 12/25R DLV	mm	325						

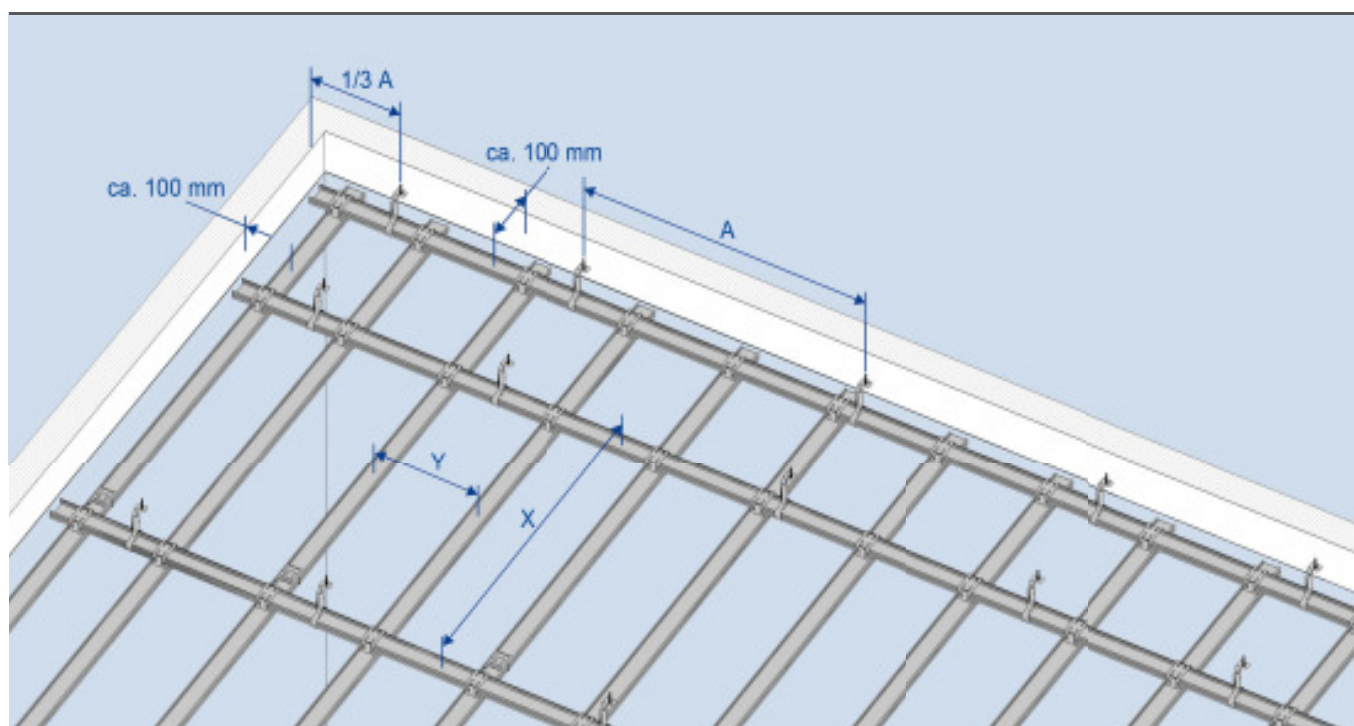

Acoustic Plaster Ceilings

CD/CD Framework
System Structure

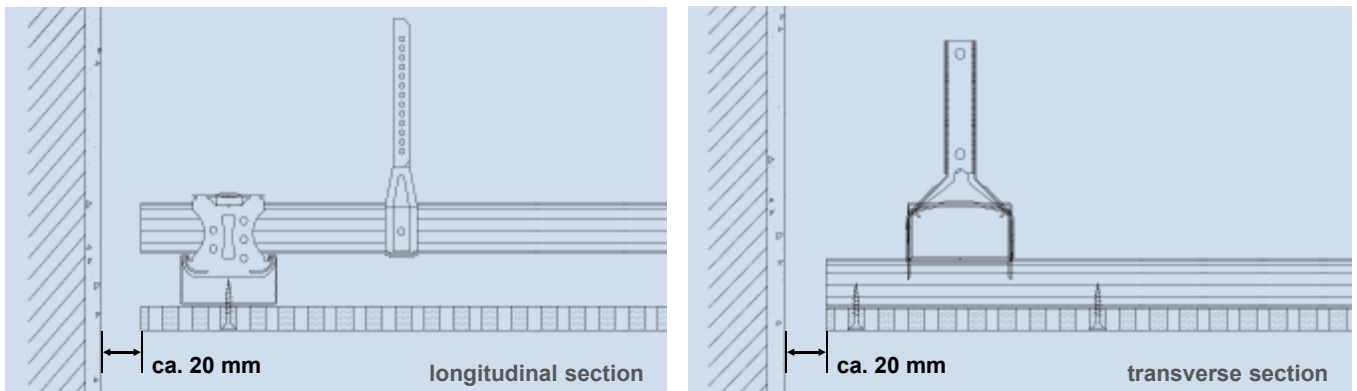

Wall Connection:

To avoid different pressure ratios / temperatures between the ceiling void and useable space, we recommend ventilating the ceiling. To do this, we advise you to fit the wall connection with an open shadow gap (approx. 20 mm) in the VoglToptec® system.

Please contact us if you require additional details or advice concerning the VoglToptec® system.

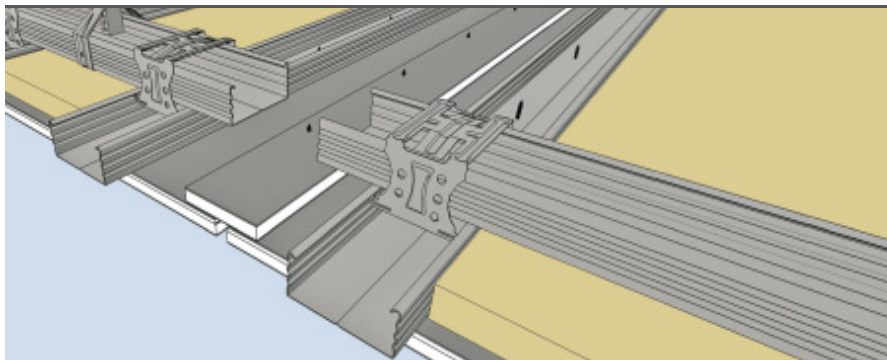

Expansion Joints:

To reduce the risk of cracking expansion joints should be installed every 10 linear metres / 100 m² of ceiling area.

The framework must be completely separated (see diagram) and the additional board strips above the joint must only be fixed to one side.

Material required per m² based on a ceiling of 100 m² (10 m x 10 m, with no allowance for wastage)

Metal framework, suspended bracket centres 1000 mm, primary grid centres 900 mm, secondary grid centres 333 mm			
Article No.	Article Description	Unit	Quantity
	Fixtures		
	Safety nails, DN 6 x 35	Piece	1.3
2016X000 50809000	Suspended brackets		
	Direct suspended bracket 50/120/200	Piece	1.3
20128 / 20151 25501000 25XXX000	Tapping screw LN 3.5 x 9.5	Piece	2.6
	or		
	Vernier hanger / Vernier base	Piece	1.3
	Vernier safety bolt	Piece	1.3
	Vernier top, 200-2400 mm	Piece	1.3
100XX000 20159000 20135000 52130000	Profiles and Connectors		
	CD profile 60/27/0.6 rK, L=XXX mm	m	4.1
	Connector, straight, CD 60/27	Piece	0.8
	Cross connectors, CD 60/27	Piece	3.3
	Perforated panel screw SN 3.5 x 30	Piece	22

Acoustic Plaster Ceilings

Installation Guide 120

VogIToptec® – Ceiling Panel Installation



Check that the ceiling grid is rigid and level (using a straight edge)

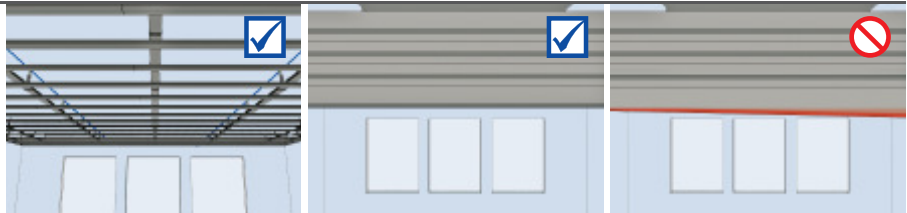

Then check the centres of the ceiling grid CD sections and adjust as necessary

Always fit straight connectors offset (see figure)

Centre distances must be measured accurately

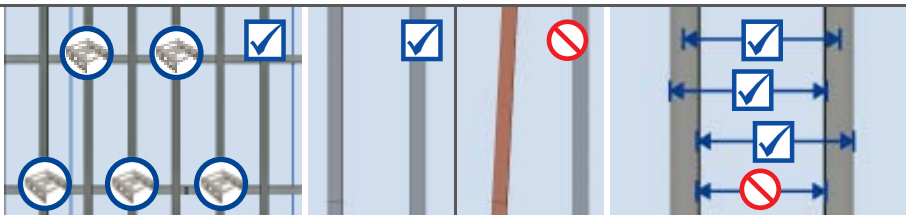

By viewing from the entrance to the area choose the panel arrangement with short edge parallel to the windows (main light direction)

Exception: Ultrakustik panels with default screw bars



We recommend the following accessories for installation:
Perforated panel screw including screw bit

Correct handling of ceiling panels:

- Always take into account the building's loading capacity when storing ceiling panels
- Do not store ceiling panels upright. Always store flat on panel pallets
- Always carry ceiling panels with short edges upright
- Protect ceiling panels from damp, relative humidity 40-80%
- Avoid major temperature fluctuations
- Do not expose the stored ceiling panels to direct sunlight

Locate the centre of the room to position the first ceiling panel and take into account the resulting ceiling perimeter to wall connections



Locate the panel in the correct position on the grid using a panel lifter if you are installing the panels alone. Alternatively, position it with the help of another person



Perforation Pattern	Centre Distance
Acoustic plaster system panel 8/18R, 12/25Q, Reflexio	334 mm
Ultrakustik panel 12/25R DLV	325 mm

Screw the panel into place ensuring that the screws are at right angles to the panel. The countersunk head must be screwed in up to 0.5 mm below the board's face

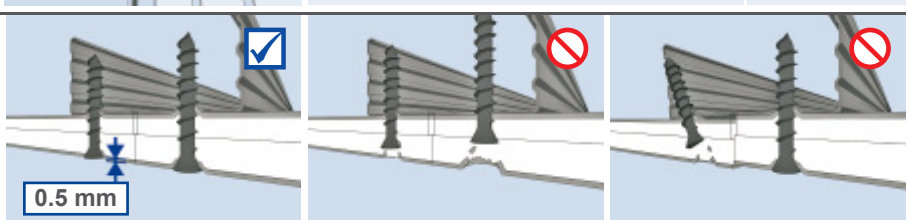

Screw centres should be a maximum 170 mm apart. The maximum distance between screws and the external edge of the panel should be 26 mm. Avoid damaging acoustic plaster system panels with countersunk heads

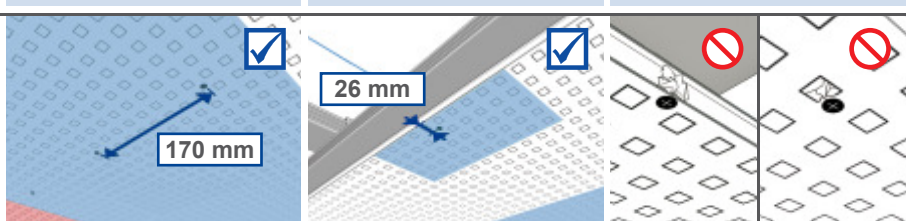

Screw the ceiling panel to the grid in the centre of the panel first, then lower the panel lifter and fix a screw into the middle of each of the short sides at the edge, then screw the long sides



Acoustic Plaster Ceilings

Installation Guide 120

VoglToptec® – Ceiling Panel Installation

Take note of panel labelling (stamp) and mount in the direction of reading (all stamps should point in the same direction)

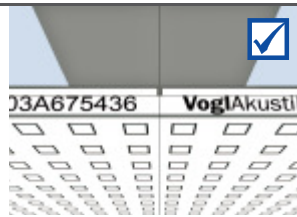

General site conditions / Manufacturer's Instructions

- Take into account the building structure's expansion joints
- Plan to include expansion joints after every 10 m or every 100 m²
- Do not allow screw heads to go through the plasterboard. Screw heads should be slightly below the board surface
- The working temperature should be at least +10°C and the building site temperature should not be below +5°C
- Installed ceiling surfaces must not be connected to the perimeter walls
- Install insulation (mineral wool layers) directly on to the ceiling panels
- Carry out any additional work on the ceiling (inspection openings, light recesses, etc.) immediately after installing the ceiling panels

Use a CD profile or straight edge as an end stop. Position the next panel beside the first by sliding it along the CD profile or straight edge and fix it in place

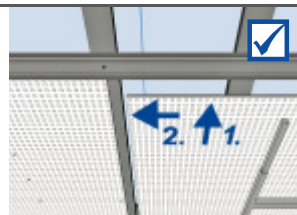

Fix the screws in the panel joint area using alternating pairs across the panels (the "zig-zag" principle), starting on the left or right next to the locating screw which has already been fixed. This will create flush joint areas

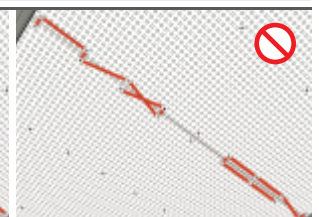
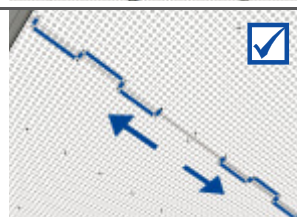

The ceiling panels are first installed lengthways, then crossways, resulting in a cross arrangement on the ceiling. The remaining areas are then boarded in the same manner, working from the centre of the room outwards

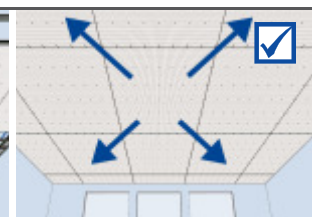
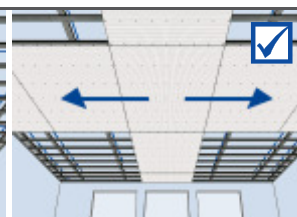
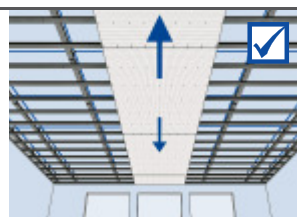

Lay the remaining ceiling panels edge-to-edge, always checking that the joints are level. Do not stagger the joints

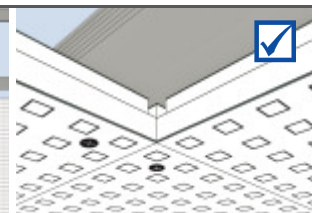
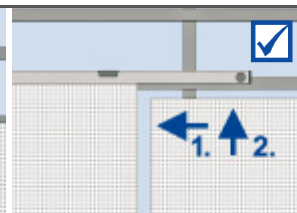
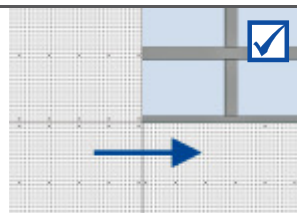

After all the panels have been installed, recheck that all joints are level and adjust, if necessary, using a screwdriver. Then check with a straight edge

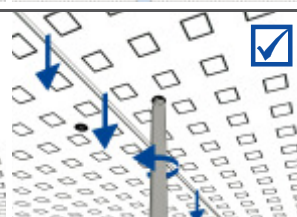
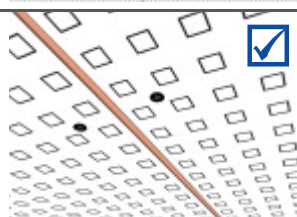

Insulation should be laid directly onto the ceiling panels in the void

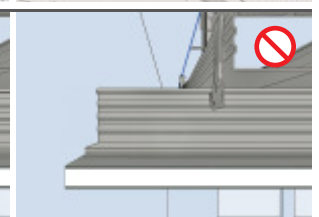
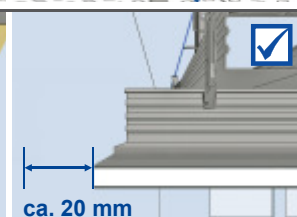

We recommend fitting an open shadow gap at the wall connection

An expansion joint of 5-10 mm should be provided every 10 running metres / 100 m²

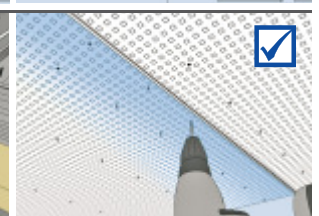
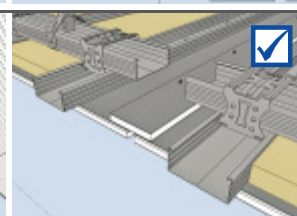
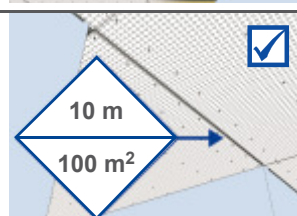

The additional board strips above the joint must only be fixed on one side

Acoustic Plaster Ceilings

Installation Guide 110

VogIToptec® – Final Coating



Check the panel joint areas and screw heads and adjust height offsets using a screwdriver if necessary

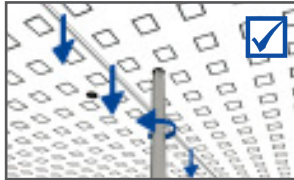

General Site Conditions

- Store the primer, adhesive and acoustic plaster in a ** frost-free environment **
- Containers should be closed during long breaks from work
- Stir all materials well before use
- The application temperature must be at least +18°C and the building site temperature not below +10°C
- Relative humidity: 40-80%
- Self-levelling, cement and asphalt screeds must be completely dried – no residual moisture
- No shock heating or cooling of the rooms during assembly or drying times – risk of cracks forming
- Store away from sun and heat

Prime the ceiling surface with Vogl Supergrund LF. The base coat must be free from dirt and separating substances and dry. Apply primer in an undiluted state with lambskin roller



Drying time: 12 hours



Apply VoglToptec® Special Adhesive generously and evenly using a lambskin roller and immediately install the plaster base fleece into the wet adhesive bed; push in with a scraper. You must not spray the adhesive

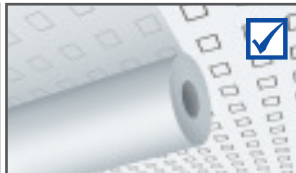
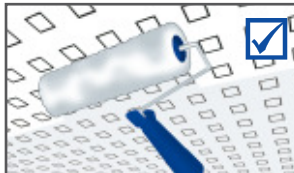

When papering, you must ensure that the special adhesive has not dried as this can cause bubbles to form. Place further lengths of the plaster base fleece overlapping (5-10 cm) and separate using a double cut

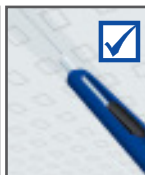

Check the surface and joints. There must not be any adhesive on the visible face of the fleece (light marks)

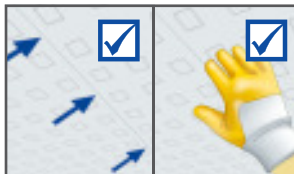

Drying time: 12 hours



Stir VoglToptec® Nano SF acoustic plaster slowly before use (2-3 minutes)



Final Coating of Acoustic Plaster Manufacturer's Instructions

- Machine requirements: plaster spray system with worm conveyor (e.g. Strobot 204S) and high-capacity compressor
- Spray distance (nozzle-ceiling) approx. 700-900 mm
- Air flow 1.5 – 2.0 bar
- Compressor capacity: at least 600 litres / min
- Nozzle size 4-6 mm (dependent on desired finish)
- Application quantities:
1st coat approx. 700 g / m²
2nd coat approx. 900 g / m²
3rd coat approx. 1100 g / m²
Total approx. 2700 g / m²

VogIToptec® Nano SF = Readymixed

The optimal speckling pattern must be adjusted depending on the building site (use brown cardboard, etc.)



Spray the acoustic plaster a circular motion when applying the first layer

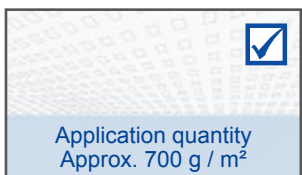
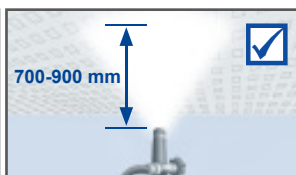

Attention – paint mist should not form; i.e. holes still visible

Drying time: 5 hours



After the drying time, apply the second coat to the ceiling, also in circular motions; holes are still slightly visible

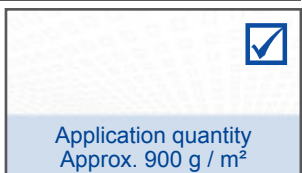
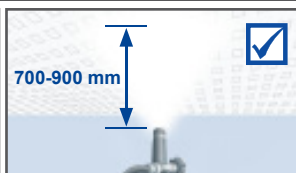

Drying time: 12 hours



Acoustic Plaster Ceilings

Installation Guide 110

VoglToptec® – Final Coating

After the drying period, apply the 3rd coat to the ceiling, also in a circular motion; holes no longer visible

Drying time: 12 hours

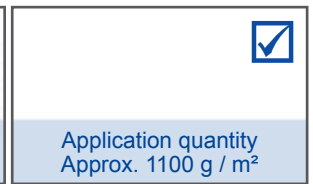
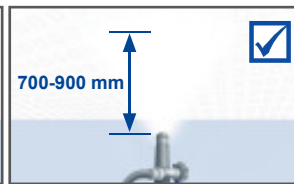

Application quantity
Approx. 1100 g / m²

Renovation / Cleaning of Acoustic Plaster Coating

To remove any dirt, the ceiling can be given another coating. Before application, sweep the ceiling with a fine hair broom

Attention: Applying paint will affect the acoustic properties of the ceiling!



With circular motions, apply another coat to the ceiling surface. Depending on the degree of dirt, the application quantity of acoustic plaster can vary

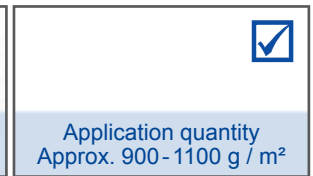
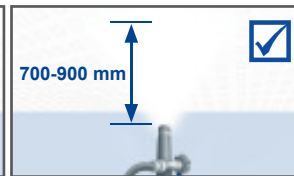

Application quantity
Approx. 900 - 1100 g / m²



Quantities required for Final Coating per m² (without any allowances for wastage)

Article No.	Article Description	Unit	Quantity
90501300	Vogl Supergrund LF	l	Approx. 0.15
90604000	VoglToptec® Special Adhesive	kg	Approx. 0.30
90605000	VoglToptec® plaster base fleece	m ²	Approx. 1.00
90602000	VoglToptec® Akustik Nano SF	kg	Approx. 2.70 – 3.00

Acoustic Plaster Ceilings

VogIToptec® System
Special Designs



VogIToptec® Thermotec The Perfect Solution for Your Acoustic Plaster Air-Handling Ceiling

Is your acoustic plaster ceiling meant to be both visually attractive and provide an efficient air-handling performance? Then our VogIToptec® Thermotec system is just the right system for you! With the perfect combination of 10 mm VogIThermotecplatten® panels and the VogIToptec® acoustic plaster system, you will get both the best cooling capacity and sound absorption performances combined an attractively finished surface. And of course, with our in-built reliable results – as all the system components come from the Vogl Ceiling System establishment.

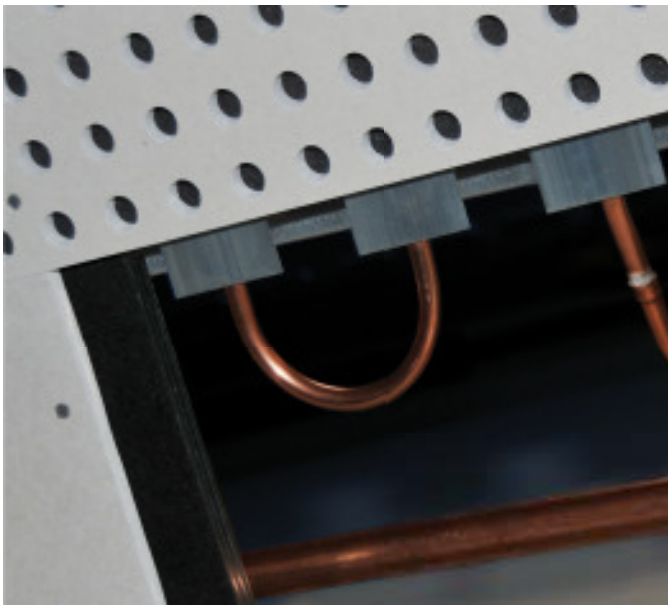

VogIToptec® with Special Foil on the Rear The Right Choice if Your Ceiling is “under pressure”.

As everyone knows a ventilation system is often required to be installed within the ceiling void to meet air exchange requirements. In many situations this ventilation must take place directly above the ceiling joints or at perimeters as the rest of the ceiling surface must be air-tight. Now there is a safe and easy-to-use solution in the VogIToptec® system. With our special foil, laminated on the reverse of our boards, the acoustic plaster ceiling remains air-tight (flow-proof) – but without compromising acoustic performance. The ideal product if your finished ceiling comes “under pressure” later on.



Acoustic Plaster Ceilings

VogIToptec® System
Advantages



Perfect Acoustic Plaster Ceilings are a Question of Technique

Acoustic plasters come into consideration where a considerable improvement in room acoustics is required and are often combined with highly effective acoustic perforation panels on both ceilings and walls. Each of these techniques can offer a highly effective acoustic solution. Together they are

unbeatable in terms of aesthetics and sound absorption. Until now, working with conventional gypsum based panels was more like using traditional smooth plasterboard panels than a modern construction method. VogIToptec® works completely differently and, above all, without requiring jointing.



Economical and Ultra-Efficient

A milestone in acoustic plaster ceilings:

- Because there is no need for board jointing, there is a considerable increase in the perforated area, thus increasing the acoustic efficiency
- Quicker and more economical use due to the precise edge-to-edge installation technique
- Sound absorption level of up to $\alpha_w = 0.95$ (absorption class A)
- Everything from one single manufacturer: a complete system, perfectly coordinated and tested
- Delivery includes Vogl screw kit
- Can also be supplied with mineral acoustic plaster

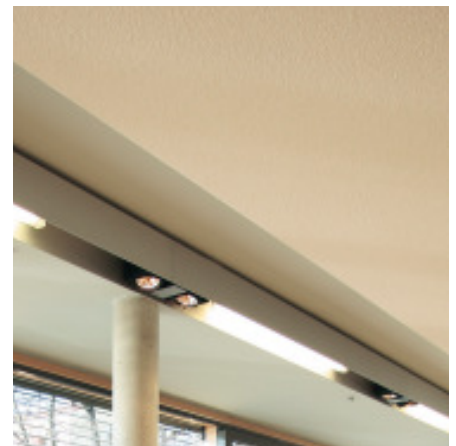
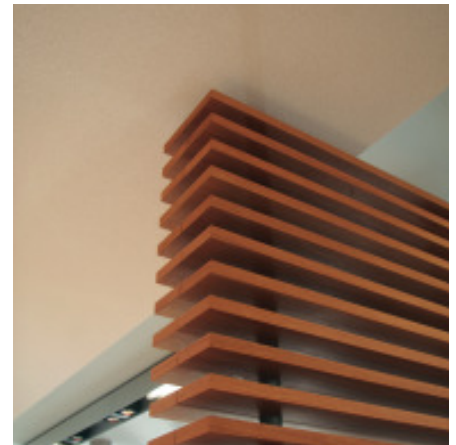

Layer Build-up for Final result

The acoustic plaster is applied in three separate coats onto the plaster base fleece over the course of several hours until an open-pored plaster layer of approx. 3 mm is achieved.



VogIToptec Akustik Nano SF

Acoustic machine-applied plaster with a very fine surface structure, particle size up to 0.5 mm

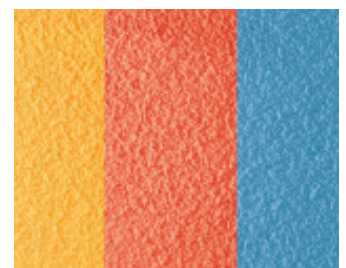

VogIToptec Akustik Color

Solid-coloured acoustic machine-applied plaster in RAL or other color cards

Acoustic Plaster Ceilings

VoglToptec® System

Tender Specification



Acoustic Plaster Ceiling – VoglToptec® System

Acoustic plaster ceiling installed as a suspended ceiling construction, clad on one side with VoglToptec® acoustic plaster system panels, with acoustic fleece on the reverse, fixed to a rigid ceiling framework made of zinc-plated metal profiles, suspended horizontally and vertically with suspended brackets and installed using materials and fixtures approved by the relevant building authorities, designed in accordance with the structural requirements with or without insulation and designed and installed in accordance with manufacturer's instructions, including all connection and jointing work, connections and fixing materials.

Ceiling system to accommodate an on-site application of machine-applied plaster consisting of VoglToptec® plaster base fleece and final coating using VoglToptec® acoustic plaster in accordance with manufacturer's instructions.

System Structure

Framework in accordance with DIN 18181:2007-02

Profiles:

Pressure-resistant design made from zinc-plated steel plate profiles CD 60/27 as primary and secondary profiles in accordance with EN 14195

Suspended Brackets:

- Suspended brackets with vernier systems (top, vernier hanger),*
- Suspended bracket with vernier systems (top, base),*
- Suspended brackets with direct suspended brackets,*
- Installed using fixing materials approved by the relevant building authorities.

Connection:

Primary-secondary profile connection using cross connectors*, suspended brackets and cross connectors in accordance with EN 13964,

Suspended bracket centre distance: max. 900 mm,

Primary profile centre distance: max. 1000 mm,

Secondary profile centre distance: 325 mm / 334 mm.*

Boarding:

Acoustic plaster system panels as perforated ceiling panels in accordance with EN 14190, laminated on the rear with acoustic fleece, one layer 12.5 mm, laid edge-to-edge and attached to the framework using perforated panel screws SN 30, screw centre distance max. 170 mm. Manufacturer's installation guidelines must be followed.

Perforation pattern / perforated area / mass:

- Reflexio / 0.0% / 10.0 kg/m²*
- 8/18R / 15.4% / 8.5 kg/m²*
- 12/25Q / 22.9% / 7.7 kg/m²*
- Ultra-acoustic 12/25R DLV / 35.3% / 6.5 kg/m²*

Distributed load:

- Less than or equal to 0.15 kN/m²*
- Less than or equal to 0.30 kN/m²*

Joint installation:

VoglToptec system in accordance with manufacturer's instructions, "edge-to-edge" installation principle with no filling, sand down screw heads and panel joints level, screw heads must not be ground, trowel application not required, manufacturer's installation guidelines must be followed.

Surface:

Suspension height: h = mm

Installation height: h = mm

Room height: h = mm

Insulation thickness: d = mm

Subsequent application: Final coating in VoglToptec® System

Whole system: Vogl ceiling systems or equivalent

* Delete as applicable

Take advantage of our wide range of online support services including brochures, newsletters, detailed plans, invitations to tender and installation guides available as PDF and with animation.



Online support, making your job easier:
www.vogl-ceilingssystem.com

- I would like to find out more. Please send me additional information.
- I have a project. Please could your project consultant contact me to arrange an appointment.
- I would like to register for the free email newsletter. The newsletter can be cancelled at any time.

Fax reply +49 (0) 9104-825-250

Name

Company

Street

Postcode/Town/City

Telephone

Fax

Email

Our mailing list is used solely for our purposes only and will not be given or sold to any other person or company for any reason. We use it to let you know of other special offers or promotions that we may be running and to keep you abreast of new and upcoming products that we are introducing as well as other innovative ideas we have to offer. We would like to keep an ongoing relationship with you and so we would like to send you an occasional email to maintain contact and let you know that your business is of interest to us. Please rest assured that this information is safe with us. At Vogl we respect everyone's privacy and will promptly remove anyone from our occasional mailing immediately on request.

Vogl Deckensysteme GmbH

Industriestrasse 10

91448 Emskirchen

Germany

Phone +49 (0) 9104-825-0

Fax +49 (0) 9104-825-250

info@vogl-deckensysteme.de

www.vogl-ceilingssystem.com

Subject to technical changes. Consumption, amounts and design details are empirical values. The details contained in this brochure correspond to the current status of technology. All valid building technology regulations, norms and guidelines must also be observed accordingly alongside our processing requirements. All rights reserved. Reprints as well as electronic reproduction, even extracts, require the express consent of Vogl Deckensysteme GmbH, Industriestrasse 10, 91448 Emskirchen, Germany.